



ADVANCED SUSPENSION TECHNOLOGY

2018 ROAD & TRACK

AUTOMOTIVE



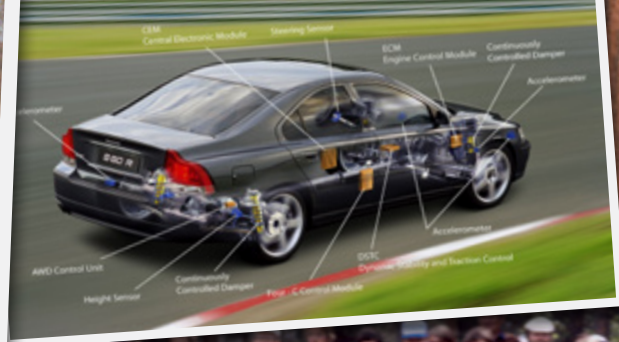

HISTORY

Ever since the company was founded in 1976, Öhlins has represented the very pinnacle of suspension technology and firmly rooted itself as an intricate part of the motorsport industry, underpinning countless world titles. That very technology has subsequently been adopted not only as the gold standard of aftermarket suspension, but is also by car and motorcycle manufacturers around the world.

Back in the 1960's, Kenth Öhlin was an up-and-coming motocross rider and showed an innate talent for mechanics. He knew how to bring the best out of his material and soon he saw himself engaged in modifying his competitor's bikes. By the time he started his business he had already designed exhaust pipes, engines and – of course – shock absorbers.

Öhlins soon became synonymous with advanced suspension. The products were not only superior in terms of technology, but as Mr. Öhlin was, and is, a very meticulous man the quality was always outstanding. The first world championship was won already in 1978, as Russian Gennady Moiseev took the 250cc title on an Öhlins equipped KTM. Since then, more than another 350 world titles have followed. The success continued in road racing and soon also in the automotive segment, in racing as well as in rally, all adding to the motorsport pedigree. But don't think that Öhlins was content, not for a minute. The company continued to grow, adding electronically controlled, semi-active suspension to its portfolio under the trademark CES. Today, this technology has revolutionized the car industry and can be found in a wide range of products from premium car manufacturers.

In the 1980's, Öhlins' achievements got the attention of industrial giants and in 1987, Öhlins was acquired by Yamaha. Under the Japanese ownership, Öhlins had the necessary financial stability to develop into a dominating player in the industry. Twenty years later, Öhlins was considered better off on its own legs and Kenth Öhlin regained the company he once had started.





PASSION,
PERFORMANCE,
PERFECTION.



WHAT WE LEARNED FROM MOTORSPORT

Competition improves the breed they say. Wise words, but here at Öhlins, competition created the breed. We are a company that has been clearly focused since day one, with a singular purpose: To win races. From Kenth Öhlins' first simple design back in 1976, through to the computer designed and tested masterpieces that we now create, every Öhlins unit is designed to give you total control, even on the very edge of the performance envelope. As our engineers say 'The ground gives better traction than air.' so every Öhlins design has one clear remit: to keep the car, bike, ATV or snowmobile maximizing traction, cornering speed and control! That is how you win races.

We enjoy a two-way dialogue with all of the teams we support. Kenth Öhlin made a clear decision many years ago, that we would never give any product away free to teams in sponsorship. Not one thing. So, every team that you see winning on Öhlins is doing so through choice, not obligation. The fact that so many teams choose to decline free product to pay for ours perhaps tells you what you need to know about the quality and ability of Öhlins race suspension products.

Over 300 world titles have been achieved on Öhlins, and many thousands of podiums. Every discipline from Touring and GT-cars, through to prototypes, Formula 1 and

Indycars. From the WRC through to World Superbikes, MX-GP and MotoGP. In every instance we work closely with the team's technical division in a two-way flow of information that allows us both to analyze data and evaluate performance. This is then poured back into the design and creation of new products as well as the continual improvement of existing lines. Winning races has taught us a lot, and these lessons are directly transferred into our aftermarket programmes where the real enthusiasts can benefit from the very best in forks, steering dampers or suspension.

Motorsport means so much to us. We have over 30 employees solely dedicated to high-end racing support and service. This team regularly briefs our designers on their results 'in the field' to ensure that every Öhlins customer, whether they're a Factory Le Mans team – or a single, discerning enthusiast gets the very best performance from their machine.

We test everything – and then we test again. But data can only tell you so much. At Öhlins, it has always been as much about 'feel' as it has been about the numbers. If it feels 'right' to the driver or rider, then that is even more important than the dry statistics. We're drivers too, and once you have driven on the product, you'll feel the difference.



ÖHLINS[®]

ADVANCED SUSPENSION TECHNOLOGY

ÖHLINS TTX-TECHNOLOGY



Öhlins Racing developed the Twin Tube (TTX) technology back in 2002, first used in formula racing series. Since then, the TTX-technology has been developed further to maximize the performance on the track and are now widely featured in all top-level racing. With the TTX-technology you receive the highest level of suspension technology, a real racing product.

The TTX products comes in a variety of dimensions, lengths and designs, all tested by our qualified test drivers. With the individual adjusters for the compression- and rebound valve you have the best possible option to set up your car for the track day.

When driving on the limit, it puts immense stress on your equipment, tires, suspension, brakes, bushings etc. Öhlins TTX-technology allows you to push the car to the limit.

Shock absorbers can experience loss of damping, cavitation when pushed over the limit of optimal performance. With Öhlins TTX-technology we are proud to say that we have eliminated cavitation with our unique design. The TTX-technology always keeps the pressure balanced within the shock absorber. Hence you will never experience a pressure drop or loss of damping performance when pushing your car to the limit to set the fastest laptime.

The Öhlins TTX shock absorbers are racer friendly shock absorbers, easy to set up, dial in and rebuild. Support is always available from the Öhlins distributors worldwide.



ÖHLINS STX-TECHNOLOGY



The STX-series are a high-pressure monotube type shock absorber. The fluid is under gas pressure and is kept separated by a dividing piston. The pressurisation prevents cavitation of the oil, and the shock absorbing action is, therefore, more even. Öhlins shock absorbers with external rebound adjustment have integrated temperature compensation. The shock absorbing effect is consequently independent of the temperature. The more advanced models permit individual adjustment of compression and rebound damping.

Öhlins shock absorbers provide the possibility of adjustment, making them adaptable to most vehicles, drivers and ranges of use. All of the shock absorbers with springs have adjustable preload of the spring action. The Öhlins STX shock absorbers are racer friendly shock absorbers, easy to set up, dial in and rebuild. Support is always available from the Öhlins distributors worldwide.



THE FEATURES OF DFV TECHNOLOGY



So what is DFV? It is Dual Flow Valve technology – and it sets us apart from our competitors. Only Öhlins has DFV technology on its road and track products.

With DFV, the oil gets an extra passageway which is active in an intermediate speed range. The damping force in this speed range influences comfort to a large degree, but does not affect handling so much. Therefore the damping can be tuned to increase comfort without negatively impacting handling. The DFV can also open during high accelerations, which for instance means that the wheel can return quickly to the ground after a sharp bump, providing grip and traction. The new Öhlins R&T range uses DFV technology on every single fitment, making it the perfect upgrade for the enthusiast that needs comfort and agility in one unit.

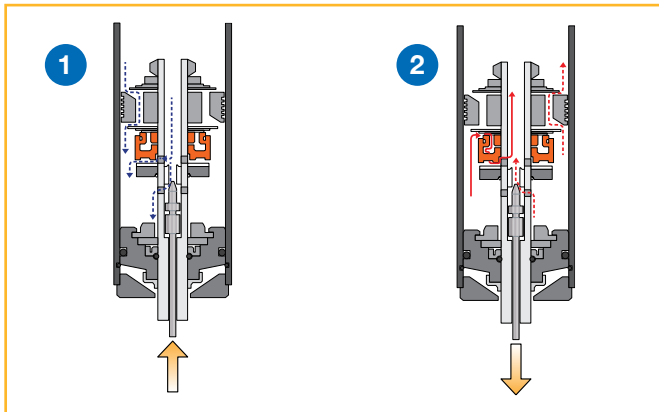

FIGURE 1: (Compression flow) At low shaft speeds, oil flows mostly through the shaft jet bleed (lower dotted arrow). At high shaft speeds, oil flows mostly through the compression ports in the piston (upper dotted arrow). At intermediate shaft speeds, which are very critical for comfort, or during sudden shaft accelerations, oil can also escape through the compression ports in the DFV (solid arrow), increasing comfort.

FIGURE 2: (Rebound flow) At low shaft speeds, oil flows mostly through the shaft jet bleed (lower dotted arrow). At high shaft speeds, oil flows mostly through the rebound ports in the piston (upper dotted arrow). At intermediate shaft speeds, which are very critical for comfort, or during sudden shaft accelerations, oil can also escape through the rebound ports in the DFV, increasing comfort and maintaining tyre contact with the road.

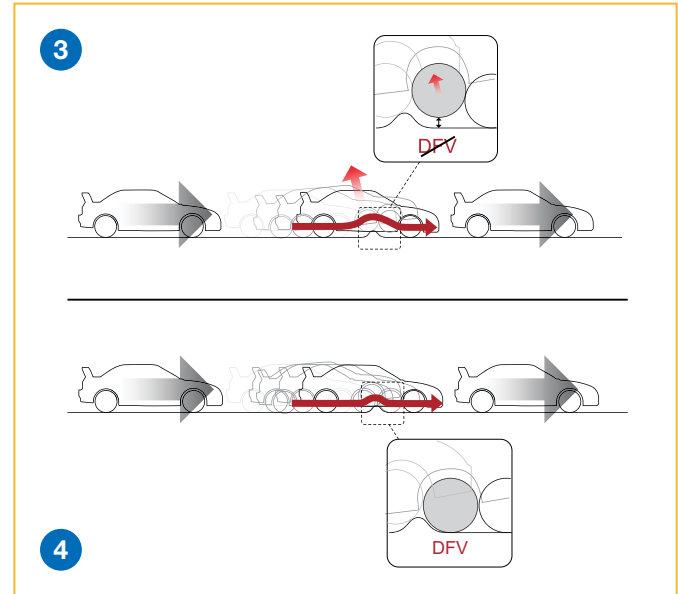

FIGURE 3: (Vehicle – no DFV) Without DFV the oil can not flow through the piston quickly enough on the rebound stroke after hitting a bump, so the tyre is not able to stay in contact with the road.

FIGURE 4: (Vehicle – DFV technique) The DFV valve opens, letting the oil flow quicker through the piston on the rebound stroke after hitting a bump, enabling the tyre to stay in contact with the road.

When adjusting ride height on coilover units, it's worth comparing how it's done. On many inferior designs, height is adjusted by raising or lowering the lower spring platform. This has the effect of compressing or extending the spring, which can limit the suspension travel that may cause topping out. The Öhlins method is to leave the spring seat in its perfect position, whilst the lower flange spins easily on the threaded body, to allow you to adjust with absolute precision whilst maintaining the perfect characteristics that we took so long to design in! Once you've set it all up, the adjuster simply locks off to maintain your exact settings.



FIGURE 5: Thermal Expansion

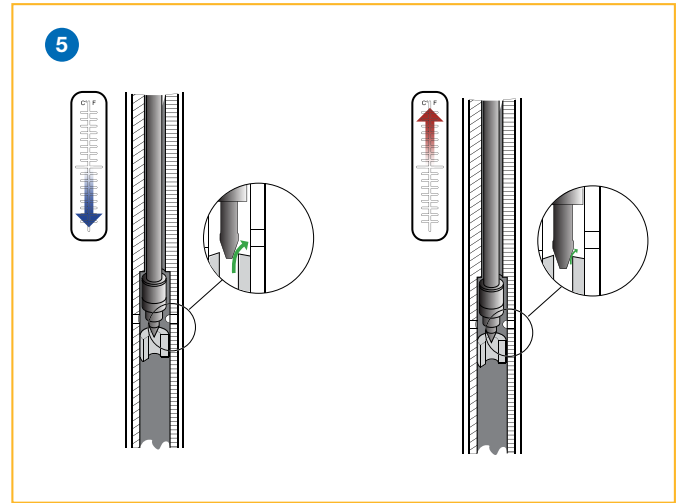

Dampers will get hot. That's one thing that you can be sure of. As the piston moves within the damper, it generates friction – and therefore, heat. Although we can't stop heat, we can deal with it, and this is yet another way that Öhlins differs from the competition. As the heat increases, the viscosity of the damper fluid can change, altering the car's handling characteristics. Our unique needle bleed valve expands with temperature, closing the gap that the fluid travels through, maintaining a consistent damping rate. The best thing of all? You won't even notice! All you'll feel is that the car responds consistently, lap after lap, turn after turn. Allowing you to concentrate on braking points and apexes whilst the Öhlins technology takes care of the damping.

These kits all work well 'out of the box', but there's still plenty of adjustment for you to set things your way. You like stiff and reactive? Or soft and forgiving? It's all there. Too much low speed rebound damping can have an adverse effect on grip, so the easily accessible adjuster at the base of the Öhlins units allows small, but positive increments of fine tuning, so you can take into account every single parameter. Sounds complicated? Nothing could be further from the truth. Just a few clicks either way from our factory settings will soon have your car responding precisely to your inputs and driving style.

The Road & Track McPherson struts also feature camber adjustable upper and lower mounts to give you the possibility to fine tune your wheels for the right occasion – whether you want to go for a ride in your neighborhood or take your car for a spin at the track on a weekend.



ÖHLINS ROAD & TRACK

THE CONCEPT

Perfection in performance. That has been the Öhlins way since 1976. We have achieved this through an obsession with detail and quality. Every part of the Öhlins manufacturing process sets new standards for the automotive industry. Whether it's material choice, design, manufacture or even a small detail like packaging. Only when it is perfect can it leave the factory. Our Road & Track range puts Öhlins incredibly high standards of research, development and manufacture within the reach of the discerning enthusiast. This range is pure Öhlins, but the good news is – you won't need a race team budget to afford it!

For us, the relationship with our customers is usually a long and fruitful one. We have supplied many of the top teams in motorsport, but also thousands of genuine enthusiasts. We only manufacture to one quality and every new

client is as important as the last. In our view, the relationship doesn't end with that initial sale. We see our role as providing support and back up thereafter, for as long as our client needs it. That's why all Öhlins units are fully serviceable and adjustable, making sure that they give faithful and dynamic service for years to come. Our fully trained and approved service centers can make your old Öhlins units perform like new and even make changes in damper characteristics to suit your set-up preferences.

Remember that our road and track range was born out of our Motorsport programme, where the impossible has to be made possible, so you can expect the same level of care and attention to detail on the R&T range. The choice of materials used is one of the key factors behind Öhlins success. Each component is surface treated to ensure reduced friction and superior



performance. The piston shaft and damper walls are micro-finished and plateau honed for optimum lubricity and low friction coefficient. This attention to detail is the same across the entire range of Öhlins products. Without this fine surface finishing, excessive friction can reduce the compliancy of the damper causing a loss of function.

Damping rate on the R&T units is fully adjustable and ties compression and rebound together as a matched setting, meaning that in 99% of cases, the units will work superbly, straight 'out of the box' with only the smallest adjustments required to suit the car or drivers individual preferences. Despite what other suspension manufacturers may tell you, comfort is king, even when you are trying to set-up a competition machine. Our vast experience in motorsport events around the globe has shown us that the fastest drivers

and riders are those who aren't being shaken to bits as they go flat out. The 'science of compliance' is a hugely important part of our design work. And last but not least, is durability. But hey, we're Swedish, so chances are you have already guessed that we're used to building components that survive one of the toughest environments in the World. The carbon steel bodies are salt spray tested and can service 240 hours of abuse, whilst still retaining function. Don't let those stunning race car looks fool you. These are real-world units for daily driven cars.

That is probably why our Road & Track products have proven to be as popular with manufacturers making the ultimate track day car as they are for aftermarket tuners and drivers wanting to upgrade the chassis performance of their cars even further.



ÖHLINS ROAD & TRACK DEVELOPMENT PROCEDURE

Ever wondered how Öhlins development process works when we develop a Road & Track kit? Then, continue reading and be amazed how much work we put into every new application.

It's a step by step process which starts with our test drivers drives the car on public roads just outside Stockholm, and on our racetrack to set a benchmark. The goal is to collect enough data about the current setup from driving on the racetrack and public roads.

What data is of our interest? We measure all specific parameters of the suspension, such as the motion ratios, ride-height, roll-centre etc. We are also performing a corner-weight of the car. This data is vital for the next stages of our development process.

With our purpose-built software, we develop an initial setting with feedback from our test drivers. From the first setting, we can begin to build an early proposal damper-setting and spring stiffness.

When the computer-based model is developed, it's time to build and fit the first Öhlins Road & Track prototypes to the car.

With the prototypes fitted to the car our technicians and engineers hand over the car to our test drivers again. A first shakedown performed on the racetrack to make sure that we have a safe product.

After the shakedown, we begin to stress the dampers with high-speed maneuvers, and we also find out if the computer modelling of our



damper-settings and spring stiffness are correct. Though our dampers are primarily intended to be used on the racetrack, our engineers and test drivers spend much time to find a comfort-setting for road use. The Road & Track dampers from Öhlins are often more comfortable than the standard suspension.

The process to find the optimum track setting and road setting may take some time. Öhlins is a perfectionist company, and that is clear in our development process. If our test drivers and engineers are not pleased with a particular setting, they change it until they are sure that this is the best possible match between Road & Track.

The final step in the Öhlins Road & Track Development Process is to

finalise and prepare the dampers for production. All documentation and prototypes used during the development phases are saved for regulatory compliance to meet legal demands.

The Öhlins Road & Track Development Process is executed for every single car model. Every setting is tailor-made and evaluated thoroughly before being transferred to series production. Our test drivers put in thousands of test kilometres to ensure the perfect handling combined with comfort. We develop our dampers after careful calculations to secure a high-quality product, which is safe to use when driving on the absolute edge. All in all, Öhlins Road & Track group takes care of testing and development to find the optimum performance so you can focus on driving your car with a smile! Drive safe!



ÖHLINS HALL OF FAME

[OHLINS.COM](https://www.ohlins.com)



350

**WORLD CHAMPIONSHIP
TITLES**

NEW

ROAD & TRACK

NEW PRODUCTS 2018



AUDI
R8

PAGE 18



FORD
MUSTANG

PAGE 32

OHLINS.COM



MERCEDES-BENZ

G350 • G500

G63 • G65

PAGE 44



PORSCHE
CAYMAN GT4

PAGE 60

NEW

ROAD & TRACK

AUDI R8



YEAR: 2006-2015

CHASSIS CODE: 1ST GENERATION • **PART NO:** AUV MS00

FEATURES

- > TTX-technology
- > Conventional shock absorber
- > 2-way adjustable
- > Height adjustable (approx. 0 to -10mm lower than standard)
- > Coil springs (ordered separately)
- > Coil springs (140 N/mm) FRONT
- > Coil springs (140 N/mm) REAR
- > Rebuildable
- > Corrosion salt spray tested (ISO 9227)
- > 2 year limited warranty



TTX

OHLINS.COM



ROAD & TRACK

BMW 1M

YEAR: 2011-2013
CHASSIS CODE: E82 • PART NO: BMZ MN01



FEATURES

- > DFV (Dual Flow Valve)
- > McPherson strut ^{FRONT}
- > Conventional shock absorber ^{REAR}
- > Single bleed adjuster
- > Height adjustable (approx. 15 mm lower than standard) ^{FRONT}
- > Height adjustable (approx. 5 mm lower than standard) ^{REAR}
- > Coil springs (60 N/mm) ^{FRONT}
- > Coil springs (110 N/mm) ^{REAR}
- > Use with original top mounts
- > Rebuildable
- > Corrosion salt spray tested (ISO 9227)
- > 2 year limited warranty



DFV

TÜV approved application.

OHLINS.COM

ROAD & TRACK

BMW 3-SERIES

YEAR: 2001-2006

CHASSIS CODE: E46 • PART NO: BMZ MI35



FEATURES

- > DFV (Dual Flow Valve)
- > McPherson strut ^{FRONT}
- > Conventional shock absorber ^{REAR}
- > Single bleed adjuster
- > Height adjustable (approx. 20 mm lower than standard) ^{FRONT}
- > Height adjustable (approx. 15 mm lower than standard) ^{REAR}
- > Coil springs (70 N/mm) ^{FRONT}
- > Coil springs (110 N/mm) ^{REAR}
- > Use with original top mounts
- > Rebuildable
- > Corrosion salt spray tested (ISO 9227)
- > 2 year limited warranty



DFV

TÜV approved application.

ROAD & TRACK

BMW 3-SERIES

YEAR: 2005-2012

CHASSIS CODE: E90/E92 • PART NO: BMS M100



FEATURES

- > DFV (Dual Flow Valve)
- > McPherson strut **FRONT**
- > Conventional shock absorber **REAR**
- > Single bleed adjuster
- > Height adjustable (approx. 20 mm lower than standard) **FRONT**
- > Height adjustable (approx. 25 mm lower than standard) **REAR**
- > Coil springs (60 N/mm) **FRONT**
- > Coil springs (70 N/mm) **REAR**
- > Use with original top mounts
- > Rebuildable
- > Corrosion salt spray tested (ISO 9227)
- > 2 year limited warranty



DFV

TÜV approved application.

OHLINS.COM

ROAD & TRACK

BMW 3-SERIES

YEAR: 2012-2018

CHASSIS CODE: F30 • PART NO: BMS MP00



FEATURES

- > DFV (Dual Flow Valve)
- > McPherson strut **FRONT**
- > Conventional shock absorber **REAR**
- > Single bleed adjuster
- > Height adjustable (approx. 20 mm lower than standard) **FRONT**
- > Height adjustable (approx. 15 mm lower than standard) **REAR**
- > Coil springs (60 N/mm) **FRONT**
- > Coil springs (160 N/mm) **REAR**
- > Use with original top mounts
- > Rebuildable
- > Corrosion salt spray tested (ISO 9227)
- > 2 year limited warranty



DFV

ROAD & TRACK

BMW M2

YEAR: 2016-2018

CHASSIS CODE: F87 • PART NO: BMS MR40



FEATURES

- > DFV (Dual Flow Valve)
- > McPherson strut **FRONT**
- > Conventional shock absorber **REAR**
- > Single bleed adjuster
- > Height adjustable (approx. 10 mm lower than standard)
- > Coil springs (ordered separately)
- > Coil springs (90 N/mm) **FRONT**
- > Coil springs (190 N/mm) **REAR**
- > Use with original top mounts
- > Rebuildable
- > Corrosion salt spray tested (ISO 9227)
- > 2 year limited warranty



DFV

OHLINS.COM

ROAD & TRACK

BMW M3

YEAR: 2001-2005

CHASSIS CODE: E46 • PART NO: BMS M130



FEATURES

- > DFV (Dual Flow Valve)
- > McPherson strut **FRONT**
- > Conventional shock absorber **REAR**
- > Single bleed adjuster
- > Height adjustable (approx. 20 mm lower than standard)
- > Coil springs (70 N/mm) **FRONT**
- > Coil springs (110 N/mm) **REAR**
- > Use with original top mounts
- > Rebuildable
- > Corrosion salt spray tested (ISO 9227)
- > 2 year limited warranty



DFV

TÜV approved application.

ROAD & TRACK

BMW M3

YEAR: 2007-2012

CHASSIS CODE: E92 • PART NO: BMS MI40



FEATURES

- > DFV (Dual Flow Valve)
- > McPherson strut **FRONT**
- > Conventional shock absorber **REAR**
- > Single bleed adjuster
- > Height adjustable (approx. 15 mm lower than standard) **FRONT**
- > Height adjustable (10 mm lower than standard) **REAR**
- > Coil springs (60 N/mm) **FRONT**
- > Coil springs (120 N/mm) **REAR**
- > Use with original top mounts
- > Rebuildable
- > Corrosion salt spray tested (ISO 9227)
- > 2 year limited warranty



DFV

TÜV approved application.

OHLINS.COM

ROAD & TRACK

BMW M3

YEAR: 2014-2018

CHASSIS CODE: F80 • PART NO: BMS MR40



FEATURES

- > DFV (Dual Flow Valve)
- > McPherson strut **FRONT**
- > Conventional shock absorber **REAR**
- > Single bleed adjuster
- > Height adjustable (approx. 10 mm lower than standard)
- > Coil springs (ordered separately)
- > Coil springs (90 N/mm) **FRONT**
- > Coil springs (230 N/mm) **REAR**
- > Use with original top mounts
- > Rebuildable
- > Corrosion salt spray tested (ISO 9227)
- > 2 year limited warranty



DFV

ROAD & TRACK

BMW M4

YEAR: 2014-2018
CHASSIS CODE: F82 • PART NO: BMS MR40



FEATURES

- > DFV (Dual Flow Valve)
- > McPherson strut **FRONT**
- > Conventional shock absorber **REAR**
- > Single bleed adjuster
- > Height adjustable (approx. 10 mm lower than standard)
- > Coil springs (ordered separately)
- > Coil springs (90 N/mm) **FRONT**
- > Coil springs (230 N/mm) **REAR**
- > Use with original top mounts
- > Rebuildable
- > Corrosion salt spray tested (ISO 9227)
- > 2 year limited warranty



DFV

OHLINS.COM

ROAD & TRACK

BMW Z4

YEAR: 2009-2011
CHASSIS CODE: E89 • PART NO: BMS MP50



FEATURES

- > DFV (Dual Flow Valve)
- > McPherson strut ^{FRONT}
- > Conventional shock absorber ^{REAR}
- > Single bleed adjuster
- > Height adjustable (approx. 10 mm lower than standard) ^{FRONT}
- > Height adjustable (approx. 0 mm lower than standard) ^{REAR}
- > Coil springs (60 N/mm) ^{FRONT}
- > Coil springs (70 N/mm) ^{REAR}
- > Use with original top mounts
- > Rebuildable
- > Corrosion salt spray tested (ISO 9227)
- > 2 year limited warranty



DFV

TÜV approved application.

ROAD & TRACK

CHEVROLET CAMARO

YEAR: 2010-2015

CHASSIS CODE: 5TH GENERATION • PART NO: CHS MP00



FEATURES

- > DFV (Dual Flow Valve)
- > Conventional shock absorber
- > Single bleed adjuster
- > Height adjustable (approx. 20 mm lower than standard) ^{FRONT}
- > Height adjustable (approx. 15 mm lower than standard) ^{REAR}
- > Coil springs (70 N/mm) ^{FRONT}
- > Coil springs (110 N/mm) ^{REAR}
- > Use with original top mounts
- > Rebuildable
- > Corrosion salt spray tested (ISO 9227)
- > 2 year limited warranty

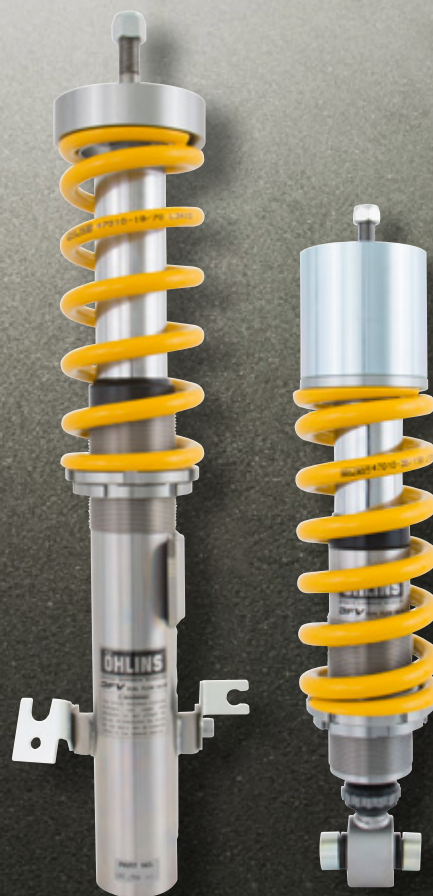

DFV

TÜV approved application.

OHLINS.COM

ROAD & TRACK

FIAT 124 SPIDER

YEAR: 2017-2018
PART NO: FIZ MP00 + MAS MP00



FEATURES

- > DFV (Dual Flow Valve)
- > Conventional shock absorber
- > Single bleed adjuster
- > Height adjustable (approx. 20 mm lower than standard) ^{FRONT}
- > Height adjustable (approx. 15 mm lower than standard) ^{REAR}
- > Coil springs (ordered separately)
- > Coil springs (100 N/mm) ^{FRONT}
- > Coil springs (40 N/mm) ^{REAR}
- > Use with original top mounts
- > Rebuildable
- > Corrosion salt spray tested (ISO 9227)
- > 2 year limited warranty



DFV

NEW

ROAD & TRACK

FORD MUSTANG

YEAR: 2015-2018

CHASSIS CODE: 6TH GENERATION • **PART NO:** FOS MR00

FEATURES

- > DFV (Dual Flow Valve)
- > McPherson strut **FRONT**
- > Conventional shock absorber **REAR**
- > Single bleed adjuster
- > Adjustable camber
- > Height adjustable (approx. 25 mm lower than standard)
- > Coil springs (ordered separately)
- > Coil springs (90 N/mm) **FRONT**
- > Coil springs (140 N/mm) **REAR**
- > Use with original top mounts
- > Front shock (McPherson) lower mount has oval mounting hole which offers you the possibility to adjust the camber angle if requested
- > Rebuildable
- > Corrosion salt spray tested (ISO 9227)
- > 2 year limited warranty



DFV

OHLINS.COM



ROAD & TRACK

HONDA CIVIC TYPE R

YEAR: 2006-2011
CHASSIS CODE: FD2 • **PART NO:** HOS MI30

FEATURES

- > DFV (Dual Flow Valve)
- > McPherson strut **FRONT**
- > Conventional shock absorber **REAR**
- > Single bleed adjuster
- > Height adjustable (approx. 15 mm lower than standard) **FRONT**
- > Height adjustable (approx. 30 mm lower than standard) **REAR**
- > Coil springs (80 N/mm) **FRONT**
- > Coil springs (24-65 N/mm Progressive) **REAR**
- > Top mounts included
- > Rebuildable
- > Corrosion salt spray tested (ISO 9227)
- > 2 year limited warranty

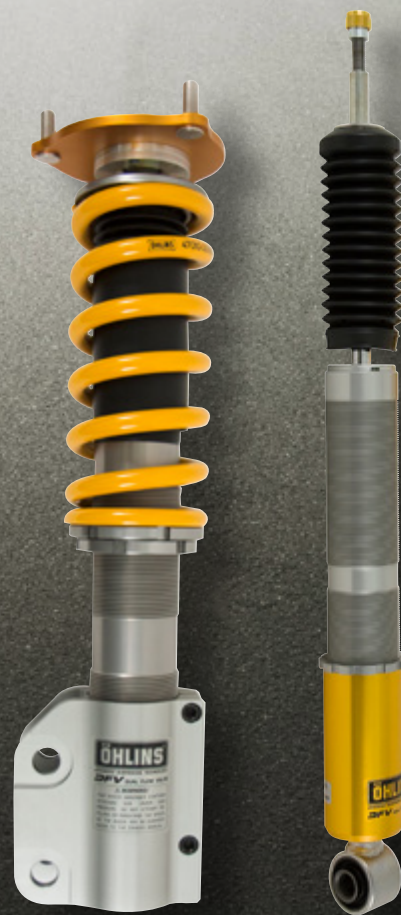

DFV

OHLINS.COM

ROAD & TRACK

HONDA S2000

YEAR: 1999-2003

CHASSIS CODE: AP1 • PART NO: HOS MI21



FEATURES

- > DFV (Dual Flow Valve)
- > Conventional shock absorber
- > Single bleed adjuster
- > Height adjustable (approx. 25 mm lower than standard)
- > Coil springs (ordered separately)
- > Coil springs (100 N/mm) **FRONT**
- > Coil springs (80 N/mm) **REAR**
- > Top mounts included
- > Rebuildable
- > Corrosion salt spray tested (ISO 9227)
- > 2 year limited warranty



DFV

TÜV approved application.

ROAD & TRACK

LEXUS IS 250

YEAR: 2005-2013

CHASSIS CODE: GSE20 • PART NO: LES M100

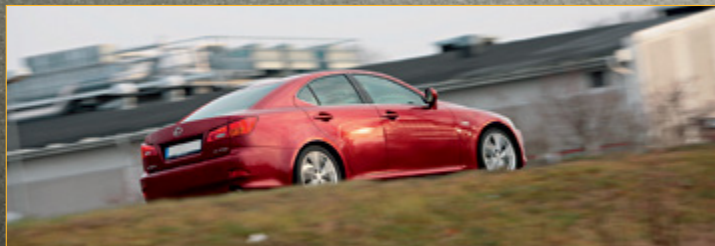

FEATURES

- > DFV (Dual Flow Valve)
- > Conventional shock absorber
- > Single bleed adjuster
- > Height adjustable (approx. 20 mm lower than standard)
- > Coil springs (100 N/mm) **FRONT**
- > Coil springs (60 N/mm) **REAR**
- > Top mounts included **FRONT**
- > Use with original top mounts **REAR**
- > Rebuildable
- > Corrosion salt spray tested (ISO 9227)
- > 2 year limited warranty

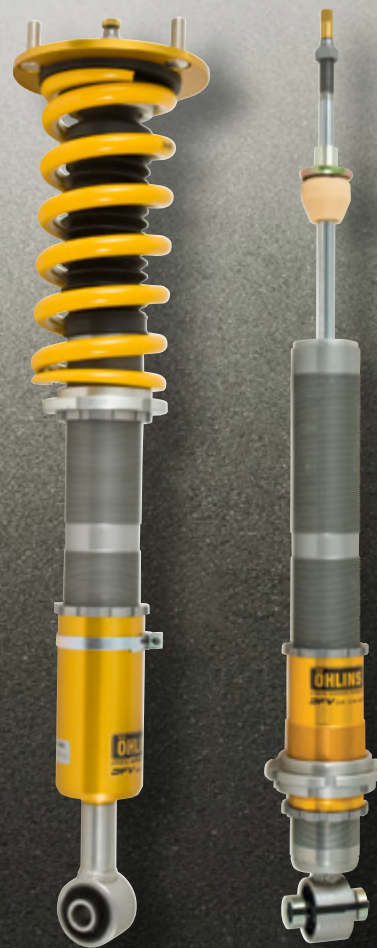

DFV

OHLINS.COM

ROAD & TRACK

LEXUS IS 350

YEAR: 2005-2013

CHASSIS CODE: GSE21 • **PART NO:** LES M100

FEATURES

- > DFV (Dual Flow Valve)
- > Conventional shock absorber
- > Single bleed adjuster
- > Height adjustable (approx. 20 mm lower than standard)
- > Coil springs (100 N/mm) ^{FRONT}
- > Coil springs (60 N/mm) ^{REAR}
- > Top mounts included ^{FRONT}
- > Use with original top mounts ^{REAR}
- > Rebuildable
- > Corrosion salt spray tested (ISO 9227)
- > 2 year limited warranty



DFV

ROAD & TRACK

LOTUS ELISE/EXIGE

YEAR: 2001-2011 • 2006-2011

PART NO: LOV 1-4D00



FEATURES

- > 1-way compression adjuster
- > 1-way rebound adjuster (shaft bleed) also have a temperature compensating function
- > Height adjustable (spring preload)
- > Coil springs (35 N/mm) FRONT
- > Coil springs (60 N/mm) REAR
- > Rebuildable
- > Revalveable



STX

OHLINS.COM

ROAD & TRACK

MAZDA MX-5

YEAR: 1989-2005

CHASSIS CODE: NA/NB • PART NO: MAS M120



FEATURES

- > DFV (Dual Flow Valve)
- > Conventional shock absorber
- > Single bleed adjuster
- > Height adjustable (approx. 20 mm lower than standard)
- > Coil springs (80 N/mm) ^{FRONT}
- > Coil springs (60 N/mm) ^{REAR}
- > Top mounts included
- > Rebuildable
- > Corrosion salt spray tested (ISO 9227)
- > 2 year limited warranty



DFV

TÜV approved application.

ROAD & TRACK

MAZDA MX-5

YEAR: 2005-2015

CHASSIS CODE: NC/EC • PART NO: MAS MI30



FEATURES

- > DFV (Dual Flow Valve)
- > Conventional shock absorber
- > Single bleed adjuster
- > Height adjustable (approx. 35 mm lower than standard)
- > Coil springs (70 N/mm) **FRONT**
- > Coil springs (40 N/mm) **REAR**
- > Top mounts included **FRONT**
- > Use with original top mounts **REAR**
- > Rebuildable
- > Corrosion salt spray tested (ISO 9227)
- > 2 year limited warranty



DFV

TÜV approved application.

OHLINS.COM

ROAD & TRACK

MAZDA MX-5

YEAR: 2016-2018

CHASSIS CODE: ND, RF • PART NO: MAS MP00



FEATURES

- > DFV (Dual Flow Valve)
- > Conventional shock absorber
- > Single bleed adjuster
- > Height adjustable (approx. 20 mm lower than standard) ^{FRONT}
- > Height adjustable (approx. 15 mm lower than standard) ^{FRONT}
- > Coil springs (ordered separately)
- > Coil springs (100 N/mm) ^{FRONT}
- > Coil springs (40 N/mm) ^{REAR}
- > Use with original top mounts
- > Rebuildable
- > Corrosion salt spray tested (ISO 9227)
- > 2 year limited warranty



DFV

TÜV approved application.

ROAD & TRACK

MAZDA RX-7

YEAR: 1991-2002

CHASSIS CODE: FD3S • PART NO: MAS MI10



FEATURES

- > DFV (Dual Flow Valve)
- > Conventional shock absorber
- > Single bleed adjuster
- > Height adjustable (approx. 25 mm lower than standard) **FRONT**
- > Height adjustable (approx. 20 mm lower than standard) **REAR**
- > Coil springs (110 N/mm)
- > Top mounts included
- > Rebuildable
- > Corrosion salt spray tested (ISO 9227)
- > 2 year limited warranty



DFV

OHLINS.COM

ROAD & TRACK

MAZDA RX-8

YEAR: 2003-2008

CHASSIS CODE: SE3P • PART NO: MAS M100



FEATURES

- > DFV (Dual Flow Valve)
- > Conventional shock absorber
- > Single bleed adjuster
- > Height adjustable (approx. 35 mm lower than standard)
- > Coil springs (80 N/mm) **FRONT**
- > Coil springs (40 N/mm) **REAR**
- > Top mounts included **FRONT**
- > Use with original top mounts **REAR**
- > Rebuildable
- > Corrosion salt spray tested (ISO 9227)
- > 2 year limited warranty



DFV



NEW

ROAD & TRACK

MERCEDES-BENZ

G350 • G500 • G63 • G65



YEAR: ALL

PART NO - LEFT FRONT: MEV 1S46, **RIGHT FRONT:** MEV 2S46,
LEFT REAR: MEV 3S46, **RIGHT REAR:** MEV 4S46

FEATURES

- > Developed specially for Mercedes Benz G-Wagen
- > Öhlins 16/46 technology
- > 46 mm piston for best performance (comfort and chassi control)
- > Remote reservoir
- > 2-way adjustable (Compression and rebound damping forces)
- > To be used with OE-springs
- > Possible to update for extended wheel travel



STX

OHLINS.COM



ROAD & TRACK

MINI COOPER S

YEAR: 2000-2006

CHASSIS CODE: R50/R53 • PART NO: BMS MI10



FEATURES

- > DFV (Dual Flow Valve)
- > McPherson strut **FRONT**
- > Conventional shock absorber **REAR**
- > Single bleed adjuster
- > Height adjustable (approx. 20 mm lower than standard) **FRONT**
- > Height adjustable (approx. 25 mm lower than standard) **REAR**
- > Coil springs (60 N/mm) **FRONT**
- > Coil springs (50 N/mm) **REAR**
- > Top mount included (Aluminium; Ball Bearing)
- > Top mounts included **FRONT**
- > Use with original top mounts **REAR**
- > Rebuildable
- > Corrosion salt spray tested (ISO 9227)
- > 2 year limited warranty



DFV

TÜV approved application.

OHLINS.COM

ROAD & TRACK

MINI COOPER

YEAR: 2006-2013

CHASSIS CODE: R56 • PART NO: BMS MI20



FEATURES

- > DFV (Dual Flow Valve)
- > McPherson strut **FRONT**
- > Conventional shock absorber **REAR**
- > Single bleed adjuster
- > Height adjustable (approx. 18 mm lower than standard)
- > Coil springs (70 N/mm) **FRONT**
- > Coil springs (50 N/mm) **REAR**
- > Use with original top mounts
- > Rebuildable
- > Corrosion salt spray tested (ISO 9227)
- > 2 year limited warranty



DFV

TÜV approved application.

ROAD & TRACK

MITSUBISHI LANCER EVO VII-IX

YEAR: 2001-2008

CHASSIS CODE: CT9A • PART NO: MIS MI00



FEATURES

- > DFV (Dual Flow Valve)
- > McPherson strut **FRONT**
- > Conventional shock absorber **REAR**
- > Single bleed adjuster
- > Height adjustable (approx. 35 mm lower than standard) **FRONT**
- > Height adjustable (approx. 30 mm lower than standard) **REAR**
- > Coil springs (100 N/mm) **FRONT**
- > Coil springs (80 N/mm) **REAR**
- > Top mounts with camber adjustments **FRONT**
- > Top mounts included
- > Rebuildable
- > Corrosion salt spray tested (ISO 9227)
- > 2 year limited warranty



DFV

TÜV approved application.

OHLINS.COM

ROAD & TRACK

MITSUBISHI LANCER EVO X

YEAR: 2007-2016
CHASSIS CODE: CZ4A • **PART NO:** MIS MI10

FEATURES

- > DFV (Dual Flow Valve)
- > McPherson strut **FRONT**
- > Conventional shock absorber **REAR**
- > Single bleed adjuster
- > Height adjustable (approx. 25 mm lower than standard)
- > Coil springs (100 N/mm) **FRONT**
- > Coil springs (70 N/mm) **REAR**
- > Top mounts with camber adjustments **FRONT**
- > Top mounts included
- > Rebuildable
- > Corrosion salt spray tested (ISO 9227)
- > 2 year limited warranty



DFV

TÜV approved application.

ROAD & TRACK

NISSAN 350Z

YEAR: 2002-2009

CHASSIS CODE: Z33 • PART NO: NIS M100



FEATURES

- > DFV (Dual Flow Valve)
- > Conventional shock absorber
- > Single bleed adjuster
- > Height adjustable (approx. 20 mm lower than standard)
- > Coil springs (100 N/mm) **FRONT**
- > Coil springs (70 N/mm) **REAR**
- > Top mounts (included)
- > Rebuildable
- > Corrosion salt spray tested (ISO 9227)
- > 2 year limited warranty



DFV

OHLINS.COM

ROAD & TRACK

NISSAN SKYLINE GT-R

YEAR: 1999-2002
CHASSIS CODE: BNR34 • PART NO: NIS MI10



FEATURES

- > DFV (Dual Flow Valve)
- > Conventional shock absorber
- > Single bleed adjuster
- > Height adjustable (approx. 30 mm lower than standard)
- > Coil springs (90 N/mm) ^{FRONT}
- > Coil springs (80 N/mm) ^{REAR}
- > Top mounts (included)
- > Rebuildable
- > Corrosion salt spray tested (ISO 9227)
- > 2 year limited warranty



DFV

TÜV approved application.

ROAD & TRACK

NISSAN GT-R

YEAR: 2007-2018
CHASSIS CODE: R35 • PART NO: NIZ MI30



FEATURES

- > DFV (Dual Flow Valve)
- > Conventional shock absorber
- > Single bleed adjuster
- > Height adjustable (approx. 10 mm lower than standard)
- > Coil springs (160 N/mm) **FRONT**
- > Coil springs (90 N/mm) **REAR**
- > Top mounts (included)
- > Rebuildable
- > Corrosion salt spray tested (ISO 9227)
- > 2 year limited warranty



DFV

TÜV approved application.

OHLINS.COM

ROAD & TRACK

OPEL/VAUXHALL

SPEEDSTER • VX220

YEAR: 2000-2005
PART NO: OPV 1-4E00



FEATURES

- > 1-way compression adjuster
- > 1-way rebound adjuster (shaft bleed) also have a temperature compensating function
- > Height adjustable (spring preload)
- > Coil springs (62 N/mm) ^{FRONT}
- > Coil springs (85 N/mm) ^{REAR}
- > Rebuildable
- > Revalveable



STX

ROAD & TRACK

PORSCHE 718

BOXSTER • BOXSTER S

YEAR: 2016-2018
CHASSIS CODE: 982 • **PART NO:** POS MP80

FEATURES

- > DFV (Dual Flow Valve)
- > McPherson strut
- > Single bleed adjuster
- > Height adjustable (approx. 20 mm lower than standard)
- > Springs ordered separately
- > Coil springs (70 N/mm) ^{FRONT}
- > Coil springs (80 N/mm) ^{REAR}
- > Use with original top mounts
- > Rebuildable
- > Corrosion salt spray tested (ISO 9227)
- > 2 year limited warranty



DFV

OHLINS.COM

ROAD & TRACK

PORSCHE 718

CAYMAN • CAYMAN S

YEAR: 2016-2018

CHASSIS CODE: 982 • PART NO: POS MP80



FEATURES

- > DFV (Dual Flow Valve)
- > McPherson strut
- > Single bleed adjuster
- > Height adjustable (approx. 20 mm lower than standard)
- > Springs ordered separately
- > Coil springs (70 N/mm) ^{FRONT}
- > Coil springs (80 N/mm) ^{REAR}
- > Use with original top mounts
- > Rebuildable
- > Corrosion salt spray tested (ISO 9227)
- > 2 year limited warranty



DFV

ROAD & TRACK

PORSCHE 981

BOXSTER • BOXSTER S • BOXSTER GTS

YEAR: 2012-2016
CHASSIS CODE: 981 • PART NO: POS MP80



FEATURES

- > DFV (Dual Flow Valve)
- > McPherson strut
- > Single bleed adjuster
- > Height adjustable (approx. 20 mm lower than standard)
- > Coil springs (70 N/mm) ^{FRONT}
- > Coil springs (80 N/mm) ^{REAR}
- > Use with original top mounts
- > Rebuildable
- > Corrosion salt spray tested (ISO 9227)
- > 2 year limited warranty



DFV

OHLINS.COM

ROAD & TRACK

PORSCHE 981

CAYMAN • CAYMAN S • CAYMAN GTS

YEAR: 2012-2016

CHASSIS CODE: 981 • PART NO: POS MP80



FEATURES

- > DFV (Dual Flow Valve)
- > McPherson strut
- > Single bleed adjuster
- > Height adjustable (approx. 20 mm lower than standard)
- > Coil springs (ordered separately)
- > Coil springs (70 N/mm) ^{FRONT}
- > Coil springs (80 N/mm) ^{REAR}
- > Use with original top mounts
- > Rebuildable
- > Corrosion salt spray tested (ISO 9227)
- > 2 year limited warranty



DFV

ROAD & TRACK

PORSCHE 981

CAYMAN GT4 • CAYMAN GT4 CLUB SPORT

YEAR: 2016-2017
CHASSIS CODE: 981 • PART NO: POF 5R00/6R10



FEATURES

- > TTX-technology
- > McPherson strut
- > 2-way adjustable
- > Height adjustable (approx. 20 mm lower than standard)
- > Springs ordered separately
- > Coil springs (100 N/mm) FRONT
- > Coil springs (120/140 N/mm) REAR
- > Use with original top mounts
- > Rebuildable
- > Corrosion salt spray tested (ISO 9227)
- > 2 year limited warranty



TTX

OHLINS.COM



NEW

ROAD & TRACK

PORSCHE 981

CAYMAN GT4

YEAR: 2016-2017
CHASSIS CODE: 981 • **PART NO:** POZ MR90

FEATURES

- > DFV (Dual Flow Valve)
- > McPherson strut
- > Single bleed adjuster
- > Springs ordered separately
- > Coil springs (80 N/mm) **FRONT**
- > Coil springs (90 N/mm) **REAR**
- > Use with original top mounts
- > Rebuildable
- > 2 year limited warranty



DFV

OHLINS.COM



ROAD & TRACK

PORSCHE 986

BOXSTER • BOXSTER S

YEAR: 1996-2004

CHASSIS CODE: 986 • PART NO: POS MR80

FEATURES

- > DFV (Dual Flow Valve)
- > McPherson strut
- > Single bleed adjuster
- > Height adjustable (approx. 20 mm lower than standard)
- > Coil springs (70 N/mm) ^{FRONT}
- > Coil springs (80 N/mm) ^{REAR}
- > Use with original top mounts
- > Rebuildable
- > Corrosion salt spray tested (ISO 9227)
- > 2 year limited warranty



DFV

OHLINS.COM



ROAD & TRACK

PORSCHE 987

BOXSTER • BOXSTER S

YEAR: 2005-2012

CHASSIS CODE: 987 • PART NO: POS MR80

FEATURES

- > DFV (Dual Flow Valve)
- > McPherson strut
- > Single bleed adjuster
- > Height adjustable (approx. 20 mm lower than standard)
- > Coil springs (70 N/mm) ^{FRONT}
- > Coil springs (80 N/mm) ^{REAR}
- > Use with original top mounts
- > Rebuildable
- > Corrosion salt spray tested (ISO 9227)
- > 2 year limited warranty



DFV

OHLINS.COM

ROAD & TRACK

PORSCHE 987

CAYMAN • CAYMAN S • CAYMAN R

YEAR: 2005-2012

CHASSIS CODE: 987 • PART NO: POS MR80



FEATURES

- > DFV (Dual Flow Valve)
- > McPherson strut
- > Single bleed adjuster
- > Height adjustable (approx. 20 mm lower than standard)
- > Coil springs (70 N/mm) **FRONT**
- > Coil springs (80 N/mm) **REAR**
- > Use with original top mounts
- > Rebuildable
- > Corrosion salt spray tested (ISO 9227)
- > 2 year limited warranty



DFV

ROAD & TRACK

PORSCHE 996

CARRERA • CARRERA CAB • TARGA

YEAR: 1999-2004

CHASSIS CODE: 996 • PART NO: POZ M100

FEATURES

- > DFV (Dual Flow Valve)
- > McPherson strut **FRONT**
- > Conventional shock absorber **REAR**
- > Single bleed adjuster
- > Height adjustable (approx. 20 mm lower than standard)
- > Coil springs (60 N/mm) **FRONT**
- > Coil springs (120 N/mm) **REAR**
- > Use with original top mounts
- > Rebuildable
- > Corrosion salt spray tested (ISO 9227)
- > 2 year limited warranty



DFV

TÜV approved application.

OHLINS.COM

ROAD & TRACK

PORSCHE 996

CARRERA 4/4S • CARRERA 4/4S CAB

YEAR: 1999-2005

CHASSIS CODE: 996 • PART NO: POZ MN02

FEATURES

- > DFV (Dual Flow Valve)
- > McPherson strut **FRONT**
- > Conventional shock absorber **REAR**
- > Single bleed adjuster
- > Height adjustable (approx. 20 mm lower than standard)
- > Coil springs (70 N/mm) **FRONT**
- > Coil springs (120 N/mm) **REAR**
- > Use with original top mounts
- > Rebuildable
- > Corrosion salt spray tested (ISO 9227)
- > 2 year limited warranty



DFV

TÜV approved application.

ROAD & TRACK

PORSCHE 996

TURBO • TURBO S • TURBO CAB • TURBO S CAB

YEAR: 2001-2005

CHASSIS CODE: 996 • PART NO: POZ MN02

FEATURES

- > DFV (Dual Flow Valve)
- > McPherson strut **FRONT**
- > Conventional shock absorber **REAR**
- > Single bleed adjuster
- > Height adjustable (approx. 20 mm lower than standard)
- > Coil springs (70 N/mm) **FRONT**
- > Coil springs (120 N/mm) **REAR**
- > Use with original top mounts
- > Rebuildable
- > Corrosion salt spray tested (ISO 9227)
- > 2 year limited warranty

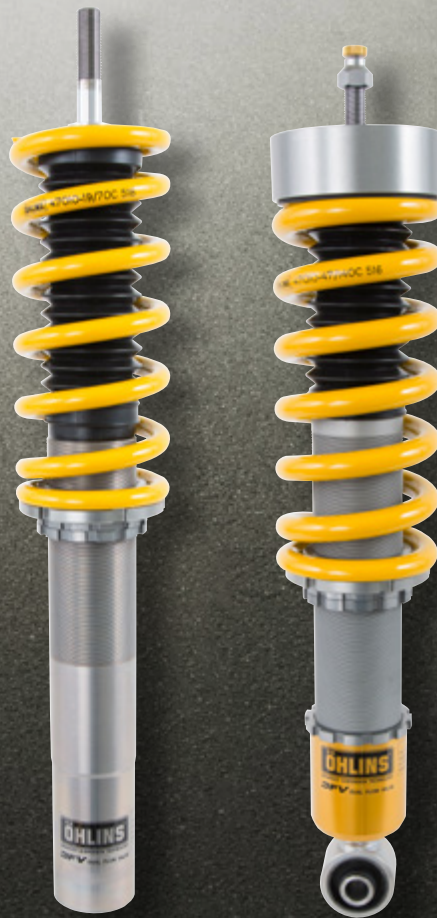

DFV

TÜV approved application.

OHLINS.COM

ROAD & TRACK

PORSCHE 996

GT2

YEAR: 1999-2005
CHASSIS CODE: 996 • PART NO: POS M110

FEATURES

- > DFV (Dual Flow Valve)
- > McPherson strut **FRONT**
- > Conventional shock absorber **REAR**
- > Single bleed adjuster
- > Height adjustable (approx. 20 mm lower than standard)
- > Coil springs (70 N/mm) **FRONT**
- > Coil springs (140 N/mm) **REAR**
- > Use with original top mounts
- > Rebuildable
- > Corrosion salt spray tested (ISO 9227)
- > 2 year limited warranty



DFV

TÜV approved application.

ROAD & TRACK

PORSCHE 996

GT3 • GT3 RS

YEAR: 1999-2005

CHASSIS CODE: 996 • PART NO: POS MI10



FEATURES

- > DFV (Dual Flow Valve)
- > McPherson strut **FRONT**
- > Conventional shock absorber **REAR**
- > Single bleed adjuster
- > Height adjustable (approx. 20 mm lower than standard)
- > Coil springs (70 N/mm) **FRONT**
- > Coil springs (140 N/mm) **REAR**
- > Use with original top mounts
- > Rebuildable
- > Corrosion salt spray tested (ISO 9227)
- > 2 year limited warranty



DFV

TÜV approved application.

OHLINS.COM

ROAD & TRACK

PORSCHE 997

CARRERA • CARRERA S • CARRERA CAB •
CARRERA S CAB

YEAR: 2005-2015

CHASSIS CODE: 997 • PART NO: POS MI20

FEATURES

- > DFV (Dual Flow Valve)
- > McPherson strut **FRONT**
- > Conventional shock absorber **REAR**
- > Single bleed adjuster
- > Height adjustable (approx. 20 mm lower than standard)
- > Coil springs (60 N/mm) **FRONT**
- > Coil springs (120 N/mm) **REAR**
- > Use with original top mounts
- > Rebuildable
- > Corrosion salt spray tested (ISO 9227)
- > 2 year limited warranty



DFV

TÜV approved application.

ROAD & TRACK

PORSCHE 997

CARRERA 4/4S • CARRERA 4/4S CAB • TARGA 4/4S

YEAR: 2005-2012

CHASSIS CODE: 997 • PART NO: POZ MN05



FEATURES

- > DFV (Dual Flow Valve)
- > McPherson strut **FRONT**
- > Conventional shock absorber **REAR**
- > Single bleed adjuster
- > Height adjustable (approx. 35 mm lower than standard)
- > Coil springs (70 N/mm) **FRONT**
- > Coil springs (120 N/mm) **REAR**
- > Use with original top mounts
- > Rebuildable
- > Corrosion salt spray tested (ISO 9227)
- > 2 year limited warranty

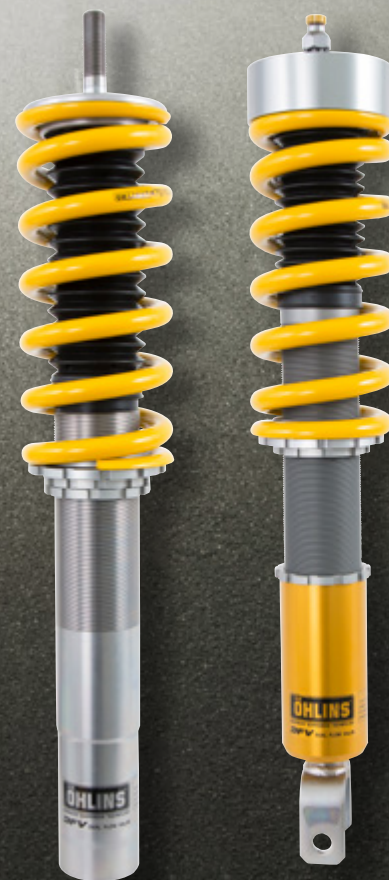

DFV

TÜV approved application.

OHLINS.COM

ROAD & TRACK

PORSCHE 997

TURBO • TURBO S • TURBO CAB • TURBO S CAB

YEAR: 2005-2012

CHASSIS CODE: 997 • PART NO: POZ MN05



FEATURES

- > DFV (Dual Flow Valve)
- > McPherson strut **FRONT**
- > Conventional shock absorber **REAR**
- > Single bleed adjuster
- > Height adjustable (approx. 35 mm lower than standard)
- > Coil springs (70 N/mm) **FRONT**
- > Coil springs (120 N/mm) **REAR**
- > Use with original top mounts
- > Rebuildable
- > Corrosion salt spray tested (ISO 9227)
- > 2 year limited warranty



DFV

TÜV approved application.

ROAD & TRACK

PORSCHE 997

GT2 • GT2 RS

YEAR: 2007-2011
CHASSIS CODE: 997 • PART NO: POZ MN04



FEATURES

- > DFV (Dual Flow Valve)
- > McPherson strut **FRONT**
- > Conventional shock absorber **REAR**
- > Single bleed adjuster
- > Height adjustable (approx. 5 mm lower than standard)
- > Coil springs (90 N/mm) **FRONT**
- > Coil springs (140 N/mm) **REAR**
- > Use with original top mounts
- > Rebuildable
- > Corrosion salt spray tested (ISO 9227)
- > 2 year limited warranty



DFV

OHLINS.COM

ROAD & TRACK

PORSCHE 997

GT3 • GT3 RS • GT3 RS 4.0

YEAR: 2007-2011
CHASSIS CODE: 997 • PART NO: POZ MN04



FEATURES

- > DFV (Dual Flow Valve)
- > McPherson strut **FRONT**
- > Conventional shock absorber **REAR**
- > Single bleed adjuster
- > Height adjustable (approx. 5 mm lower than standard)
- > Coil springs (90 N/mm) **FRONT**
- > Coil springs (140 N/mm) **REAR**
- > Use with original top mounts
- > Rebuildable
- > Corrosion salt spray tested (ISO 9227)
- > 2 year limited warranty



DFV

TÜV approved application.

ROAD & TRACK

PORSCHE 997

GT3 RS

YEAR: 2007-2011

CHASSIS CODE: 997 • PART NO: POF 5Q00/6N01



FEATURES

- > TTX-technology
- > McPherson strut **FRONT**
- > Conventional shock absorber **REAR**
- > Single bleed adjuster
- > Height adjustable (approx. 20 mm lower than standard)
- > Coil springs (ordered separately)
- > Coil springs (120 N/mm) **FRONT**
- > Coil springs (170 N/mm) **REAR**
- > Use with original top mounts
- > Rebuildable
- > 2 year limited warranty

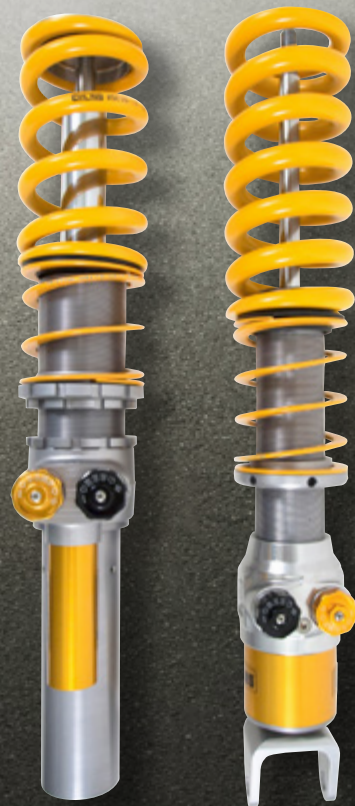

TTX

OHLINS.COM

ROAD & TRACK

PORSCHE 991

CARRERA • CARRERA S

YEAR: 2011-2017

CHASSIS CODE: 991 • PART NO: POS MP70



FEATURES

- > DFV (Dual Flow Valve)
- > McPherson strut **FRONT**
- > Conventional shock absorber **REAR**
- > Single bleed adjuster
- > Height adjustable (approx. 10 mm lower than standard)
- > Coil springs (ordered separately)
- > Coil springs (70 N/mm) **FRONT**
- > Coil springs (120 N/mm) **REAR**
- > Use with original top mounts
- > Rebuildable
- > Corrosion salt spray tested (ISO 9227)
- > 2 year limited warranty



DFV

ROAD & TRACK

PORSCHE 991

GT3 • GT3 RS

YEAR: 2013-2017 • 2016-2017

CHASSIS CODE: 991 • PART NO: POF 5R00/6R00



FEATURES

- > TTX-technology
- > McPherson strut **FRONT**
- > Conventional shock absorber **REAR**
- > 2-way adjustable
- > Single bleed adjuster **REAR**
- > Height adjustable (approx. 20 mm lower than standard)
- > Coil springs (ordered separately)
- > Coil springs (100/120 N/mm) **FRONT**
- > Coil springs (200 N/mm) **REAR**
- > Use with original top mounts
- > Rebuildable
- > 2 year limited warranty



TTX

OHLINS.COM

ROAD & TRACK

RENAULT

MÉGANE RS TROPHY 275 • MÉGANE RS 275 TROPHY-R



FEATURES

- > DFV (Dual Flow Valve)
- > McPherson strut **FRONT**
- > Conventional Shock Absorber **REAR**
- > Single bleed adjuster
- > Rebuildable
- > Corrosion salt spray tested (ISO 9227)
- > 2 year limited warranty

This kit is available as an upgrade option through the Renault dealer network.



DFV



ROAD & TRACK

SUBARU BRZ

YEAR: 2012-2018

CHASSIS CODE: ZC6 • PART NO: SUS MP21



FEATURES

- > DFV (Dual Flow Valve)
- > McPherson strut **FRONT**
- > Conventional Shock Absorber **REAR**
- > Single bleed adjuster
- > Height adjustable (approx. 20 mm lower than standard) **FRONT**
- > Height adjustable (approx. 15 mm lower than standard) **REAR**
- > Coil springs (ordered separately)
- > Coil springs (40 N/mm) **FRONT**
- > Coil springs (30 N/mm) **REAR**
- > Use with original top mounts
- > Rebuildable
- > Corrosion salt spray tested (ISO 9227)
- > 2 year limited warranty



DFV

TÜV approved application.

OHLINS.COM

ROAD & TRACK

SUBARU IMPREZA WRX STI

YEAR: 2007-2011

CHASSIS CODE: GRB, GRF • PART NO: SUS M110



FEATURES

- > DFV (Dual Flow Valve)
- > McPherson strut **FRONT**
- > Conventional Shock Absorber **REAR**
- > Single bleed adjuster
- > Height adjustable (approx. 20 mm lower than standard)
- > Coil springs (90 N/mm) **FRONT**
- > Coil springs (70 N/mm) **REAR**
- > Top mounts with camber adjustments (included) **FRONT**
- > Top mounts (included) **REAR**
- > Rebuildable
- > Corrosion salt spray tested (ISO 9227)
- > 2 year limited warranty



DFV

TÜV approved application.

ROAD & TRACK

SUBARU LEGACY

YEAR: 2004-2009

CHASSIS CODE: BP5, BH5 • **PART NO:** SUS MI00

FEATURES

- > DFV (Dual Flow Valve)
- > McPherson strut ^{FRONT}
- > Conventional Shock Absorber ^{REAR}
- > Single bleed adjuster
- > Height adjustable (approx. 25 mm lower than standard)
- > Coil springs (90 N/mm) ^{FRONT}
- > Coil springs (70 N/mm) ^{REAR}
- > Top mounts with camber adjustments (included) ^{FRONT}
- > Top mounts (included) ^{REAR}
- > Rebuildable
- > Corrosion salt spray tested (ISO 9227)
- > 2 year limited warranty



DFV

OHLINS.COM

ROAD & TRACK

SUBARU WRX STI

YEAR: 2015-2018

CHASSIS CODE: VAF • PART NO: SUS M110



FEATURES

- > DFV (Dual Flow Valve)
- > McPherson strut **FRONT**
- > Conventional Shock Absorber **REAR**
- > Single bleed adjuster
- > Height adjustable (approx. 25 mm lower than standard) **FRONT**
- > Height adjustable (approx. 15 mm lower than standard) **REAR**
- > Coil springs (90 N/mm) **FRONT**
- > Coil springs (70 N/mm) **REAR**
- > Top mounts with camber adjustments (included) **FRONT**
- > Top mounts (included) **REAR**
- > Rebuildable
- > Corrosion salt spray tested (ISO 9227)
- > 2 year limited warranty



DFV

TÜV approved application.

ROAD & TRACK

SUZUKI SWIFT SPORT

YEAR: 2004-2010
CHASSIS CODE: ZC31S • PART NO: SZS M100



FEATURES

- > DFV (Dual Flow Valve)
- > McPherson strut **FRONT**
- > Conventional Shock Absorber **REAR**
- > Single bleed adjuster
- > Height adjustable (approx. 30 mm lower than standard)
- > Coil springs (50 N/mm) **FRONT**
- > Coil springs (progressive) **REAR**
- > Use with original top mounts
- > Rebuildable
- > Corrosion salt spray tested (ISO 9227)
- > 2 year limited warranty



DFV

TÜV approved application.

OHLINS.COM

ROAD & TRACK

TOYOTA GT86

YEAR: 2012-2018
CHASSIS CODE: ZN6 • PART NO: SUS MP21



FEATURES

- > DFV (Dual Flow Valve)
- > McPherson strut **FRONT**
- > Conventional Shock Absorber **REAR**
- > Single bleed adjuster
- > Height adjustable (approx. 20 mm lower than standard) **FRONT**
- > Height adjustable (approx. 15 mm lower than standard) **REAR**
- > Coil springs (ordered separately)
- > Coil springs (40 N/mm) **FRONT**
- > Coil springs (30 N/mm) **REAR**
- > Use with original top mounts
- > Rebuildable
- > Corrosion salt spray tested (ISO 9227)
- > 2 year limited warranty



DFV

TÜV approved application.

ROAD & TRACK

VOLKSWAGEN

GOLF GTI V • GOLF GT V

YEAR: 2004-2009

CHASSIS CODE: 1KAXX • PART NO: VWS M110



FEATURES

- > DFV (Dual Flow Valve)
- > McPherson strut **FRONT**
- > Conventional shock absorber **REAR**
- > Single bleed adjuster
- > Height adjustable (approx. 20 mm lower than standard)
- > Coil springs (70 N/mm) **FRONT**
- > Coil springs (60 N/mm) **REAR**
- > Use with original top mounts
- > Rebuildable
- > Corrosion salt spray tested (ISO 9227)
- > 2 year limited warranty



DFV

TÜV approved application.

OHLINS.COM

ROAD & TRACK

VOLKSWAGEN

GOLF GTI VI • GOLF GT VI

YEAR: 2009-2013

CHASSIS CODE: 1KCCZ • **PART NO:** VWS MI10

FEATURES

- > DFV (Dual Flow Valve)
- > McPherson strut **FRONT**
- > Conventional shock absorber **REAR**
- > Single bleed adjuster
- > Height adjustable (approx. 20 mm lower than standard)
- > Coil springs (70 N/mm) **FRONT**
- > Coil springs (60 N/mm) **REAR**
- > Use with original top mounts
- > Rebuildable
- > Corrosion salt spray tested (ISO 9227)
- > 2 year limited warranty



DFV

TÜV approved application.

ROAD & TRACK

VOLKSWAGEN GOLF GTI VII

YEAR: 2013-2018

CHASSIS CODE: 5G • PART NO: VWS MP21



FEATURES

- > DFV (Dual Flow Valve)
- > McPherson strut **FRONT**
- > Conventional shock absorber **REAR**
- > Single bleed adjuster
- > Height adjustable (approx. 15 mm lower than standard)
- > Coil springs (ordered separately)
- > Coil springs (70 N/mm) **FRONT**
- > Coil springs (50 N/mm) **REAR**
- > Use with original top mounts
- > Rebuildable
- > Corrosion salt spray tested (ISO 9227)
- > 2 year limited warranty



DFV

TÜV approved application.

OHLINS.COM

ROAD & TRACK

VOLKSWAGEN SCIROCCO

YEAR: 2008-2017

PART NO: VWS MI10



FEATURES

- > DFV (Dual Flow Valve)
- > McPherson strut **FRONT**
- > Conventional shock absorber **REAR**
- > Single bleed adjuster
- > Height adjustable (approx. 20 mm lower than standard)
- > Coil springs (70 N/mm) **FRONT**
- > Coil springs (60 N/mm) **REAR**
- > Use with original top mounts
- > Rebuildable
- > Corrosion salt spray tested (ISO 9227)
- > 2 year limited warranty



DFV

TÜV approved application.

CANCELLATION KIT

Öhlins Racing provides cancellation kits for cars equipped with originally equipped (OE) electronically adjustable shock absorbers. Using a cancellation kit from Öhlins prevents error messages from appearing at the display after switching shock absorbers on the car.

- > Avoids error messages when changing the shock absorber from OE.
- > The car ECU works in conjunction with this cancellation kit and all functions of the car remains as OE.
- > Can also be used for other manufacturers and OE aftermarket suspensions separately
- > The kit comes with Mounting instruction and one kit contains parts for whole car.

MODEL	PART NO	KIT
BMW M3 F80	35020-02	Cancellation kit EDC
BMW M3 E92	35020-04	Cancellation kit EDC
BMW M4 F82	35020-02	Cancellation kit EDC
BMW 3-SERIES F30	35020-03	Cancellation kit EDC
BMW Z4	35020-05	Cancellation kit EDC
Nissan GT-R R35	35020-06	Cancellation kit
Porsche 981	35020-08	Cancellation kit PASM
Porsche 991	35020-07	Cancellation kit PASM
Porsche 991 GT3	35020-13	Cancellation kit PASM
Porsche 997 Cab	35020-09	Cancellation kit PASM
Porsche 997	35020-10	Cancellation kit PASM
Volkswagen Golf VI	35020-14	Cancellation kit DDC
Volkswagen Golf VII	35020-15	Cancellation kit DDC



ÖHLINS ORIGINAL MERCHANDISE

Öhlins Original Merchandise is designed to keep you stylish, comfortable, functional and durable. Its designed, tested and scrutinized by Öhlins crew and represent our values and heritage.

To see the whole Merchandise collection visit www.ohlins.com or your local Öhlins distributor.

OHLINS.COM



ÖHLINS STICKERS

Öhlins stickers range gives you the option to personalize your car or shock. Stickers can be found through the Öhlins network.



STICKERBOX

Part No: 10207-02

Size: 73 x 30 mm



Ö YELLOW SMALL

Part No: 11221-08

Size: 17 x 32 mm



Ö BLACK SMALL

Part No: 11221-09

Size: 17 x 32 mm



Ö YELLOW

Part No: 11221-06

Size: 43 x 80 mm

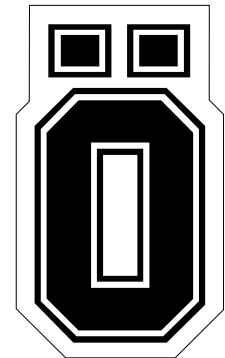

Ö BLACK

Part No: 11221-07

Size: 43 x 80 mm



ÖHLINS BLUE/YELLOW

Part No: 01196-02

Size: 74 x 28 mm



ÖHLINS BLACK/WHITE

Part No: 01196-01

Size: 74 x 28 mm



ÖHLINS BLUE/YELLOW MEDIUM

Part No: 11221-01

Size: 210 x 79 mm

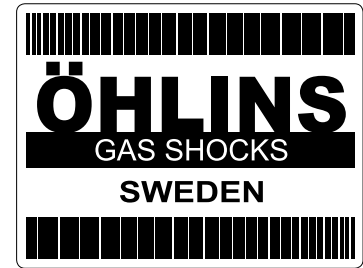

ÖHLINS RETRO BLACK

Part No: 11221-04

Size: 63 x 47 mm



ÖHLINS BLACK/WHITE MEDIUM

Part No: 11221-02

Size: 210 x 79 mm

(TRANSPARENT BACKGROUND)

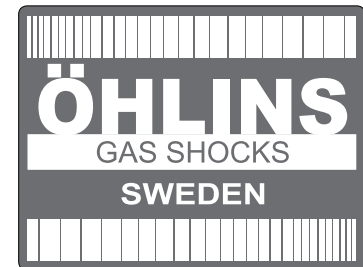

ÖHLINS RETRO WHITE

Part No: 11221-05

Size: 63 x 47 mm

PRODUCT RANGE 2018

MODEL	MODEL CODE	YEAR	PART NO	TÜV APPROVED	PAGE
AUDI					
R8	1 st generation	2006-2015	AUV MS00	-	18
BMW					
1M	E82	2011-2013	BMZ MN01	YES	20
3-SERIES	E46	2001-2006	BMZ MI35	YES	21
3-SERIES	E90/E92	2005-2012	BMS MI00	YES	22
3-SERIES	F30	2012-2018	BMS MP00	-	23
M2	F87	2016-2018	BMS MR40	-	24
M3	E46	2001-2005	BMS MI30	YES	25
M3	E92	2007-2012	BMS MI40	YES	26
M3	F80	2014-2018	BMS MR40	-	27
M4	F82	2014-2018	BMS MR40	-	28
Z4	E89	2009-2011	BMS MP50	YES	29
CHEVROLET					
CAMARO	5 th Generation	2010-2015	CHS MP00	YES	30
FIAT					
124 SPIDER	-	2017-2018	FIZ MP00 + MAS MP00	-	31
FORD					
MUSTANG	6 th Generation	2015-2018	FOS MR00	-	32
HONDA					
CIVIC TYPE R	FD2	2006-2011	HOS MI30	-	34
S2000	AP1	1999-2003	HOS MI21	YES	35
LEXUS					
IS 250	GSE21	2005-2013	LES MI00	-	36
IS 350	GSE20	2005-2013	LES MI00	-	37
LOTUS					
ELISE	-	2001-2011	LOV 1-4D00	-	38
EXIGE	-	2006-2011	LOV 1-4D00	-	38
MAZDA					
MX-5	NA/NB	1989-2005	MAS MI20	YES	39
MX-5	NC/EC	2005-2015	MAS MI30	YES	40
MX-5	ND, RF	2016-2018	MAS MP00	YES	41
RX-7	FD3S	1991-2002	MAS MI10	-	42
RX-8	SE3P	2003-2008	MAS MI00	-	43
MERCEDES-BENZ					
G350 • G500 • G63 • G65	-	ALL	MEV 1S46-4S46	-	44
MINI					
COOPER S	R50/R53	2000-2006	BMS MI10	YES	46
COOPER	R56	2006-2013	BMS MI20	YES	47
MITSUBISHI					
LANCER EVO VII-IX	CT9A	2001-2008	MIS MI00	YES	48
LANCER EVO X	CZ4A	2007-2016	MIS MI10	YES	49
NISSAN					
350Z	Z33	2002-2009	NIS MI00	-	50

MODEL	MODEL CODE	YEAR	PART NO	TÜV APPROVED	PAGE
SKYLINE GT-R	BNR34	1999-2002	NIS MI10	YES	51
GT-R	R35	2007-2018	NIZ MI30	YES	52
OPEL • VAUXHALL					
SPEEDSTER • VX220	-	2000-2005	OPV 1-4E00	-	53
PORSCHE 718					
BOXSTER • BOXSTER S	982	2016-2018	POS MP80	-	54
CAYMAN • CAYMAN S	982	2016-2018	POS MP80	-	55
PORSCHE 981					
BOXSTER • BOXSTER S • BOXSTER GTS	981	2012-2016	POS MP80	-	56
CAYMAN • CAYMAN S • CAYMAN GTS	981	2012-2016	POS MP80	-	57
CAYMAN GT4 • CAYMAN GT4 CLUB SPORT (TTX)	981	2016-2017	POF 5R00/6R10	-	58
CAYMAN GT4	981	2016-2017	POZ MR90	-	60
PORSCHE 986					
BOXSTER • BOXSTER S	986	2004-2012	POS MP80	-	62
PORSCHE 987					
BOXSTER • BOXSTER S • CAYMAN • CAYMAN S • CAYMAN R	987	2004-2012	POS MP80	-	64-65
PORSCHE 996					
CARRERA • CARRERA CAB • TARGA	996	1999-2004	POZ MI00	YES	66
CARRERA 4/4S • CARRERA 4/4S CAB	996	1999-2005	POZ MN02	YES	67
TURBO • TURBO S • TURBO CAB • TURBO S CAB	996	2001-2005	POZ MN02	YES	68
GT2	996	1999-2005	POS MI10	YES	69
GT3 • GT3 RS	996	1999-2005	POS MI10	YES	70
PORSCHE 997					
CARRERA • CARRERA S • CARRERA CAB • CARRERA S CAB	997	2005-2015	POS MI20	YES	71
CARRERA 4/4S • CARRERA 4/4S CAB • TARGA 4/4S	997	2005-2012	POZ MN05	YES	72
TURBO • TURBO S • TURBO CAB • TURBO S CAB	997	2005-2012	POZ MN05	YES	73
GT2 • GT2 RS	997	2007-2011	POZ MN04	-	74
GT3 • GT3 RS • GT3 RS 4.0	997	2007-2011	POZ MN04	YES	75
GT3 RS (TTX)	997	2007-2011	POF 5Q00/6N01	-	76
PORSCHE 991					
CARRERA • CARRERA S	991	2011-2017	POS MP70	-	77
GT3 • GT3 RS (TTX)	991	2013-2017 • 2016-2017	POF 5R00/6R00	-	78
RENAULT					
MÉGANÉ RS TROPHY 275 • MÉGANÉ RS 275 TROPHY-R	*	*	*	-	79
SUBARU					
BRZ	ZC6	2012-2018	SUS MP21	YES	80
IMPREZA WRX STI	GRB, GRF	2007-2011	SUS MI10	YES	81
LEGACY	BP5, BH5	2004-2009	SUS MI00	-	82
WRX STI	VAF	2015-2018	SUS MI10	YES	83
SUZUKI					
SWIFT SPORT	ZC31S	2004-2010	SZS MI00	YES	84
TOYOTA					
GT86	ZN6	2012-2018	SUS MP21	YES	85
VOLKSWAGEN					
GOLF GTI V • GOLF GT V	1KAXX	2004-2009	VWS MI10	YES	86
GOLF GTI VI • GOLF GT VI	1KCCZ	2009-2013	VWS MI10	YES	87
GOLF GTI VII	5G	2013-2018	VWS MP20	YES	88
SCIROCCO	-	2008-2017	VWS MI10	YES	89

FOR MORE CONTACT INFORMATION PLEASE VISIT

Full information about which models Öhlins products are available for, please contact your local Öhlins distributor.

AFRICA

KENYA Azar Anwar Motorsport

SOUTH AFRICA VM Innovation Ltd

ASIA

CHINA Gusto Technik Co.

HONG KONG Gusto Technik Co.

INDONESIA PT. Madani Sentra Multi Jasa

JAPAN Carrozzeria Japan Co., Ltd

MALAYSIA Trans Techno Enterprise S/B

PHILIPPINES Access Plus / T.A. Marketing

SINGAPORE Sporting Motors Pte Ltd

SOUTH KOREA Neobis Int Co., Ltd

THAILAND Öhlins Asia

TAIWAN Capricore Trading Co., Ltd

VIETNAM Dia Hoang Gia, HCM

EUROPE

AUSTRIA Öhlins DTC

BELGIUM Öhlins DTC

BULGARIA Öhlins DTC

CROATIA Öhlins DTC

CYPRUS Öhlins DTC

CZECH REPUBLIC Öhlins DTC

DENMARK Öhlins DTC

ESTONIA VTR Motors OÜ

FINLAND Öhlins Auto Norden

FRANCE PFP Racing

GERMANY Öhlins DTC

GREECE Öhlins DTC

HUNGARIA Öhlins DTC

ITALY Andreani Group International s.r.l

LATVIA

Bairons Sia

Motofavorits

LITHUANIA

UAB Proracing

Jiezno UAB Juta

LUXEMBURG Öhlins DTC

THE NETHERLANDS Öhlins DTC

NORWAY Öhlins Auto Norden

POLAND FF-Sport

PORTUGAL Maxi-Shocks

REPUBLIC OF IRELAND Öhlins DTC

ROMANIA Öhlins DTC

RUSSIA

Kajma Racing

Master-Sport Ltd

SLOVAKIA Öhlins DTC

SLOVENIA Öhlins DTC

SPAIN Andreani MHS Ibérica, SL

SWEDEN Öhlins Auto Norden

SWITZERLAND Öhlins DTC

TURKEY Öhlins DTC

UKRAINE Öhlins DTC

UNITED KINGDOM Öhlins DTC

MIDDLE EAST

DUBAI Automotive Design & Development

ISRAEL G-Force Motorsport

LEBANON Lead Race Engineering

NORTH & CENTRAL AMERICA

CANADA Öhlins USA Inc.

MEXICO Conequis SA

USA Öhlins USA Inc.

PACIFIC

AUSTRALIA Steve Cramer Products

NEW ZEALAND Kiwi Suspension Solutions

SOUTH AMERICA

ARGENTINA Alpes Racing

BRAZIL JP3 Motorsport

EQUADOR RPM Imports

PARAGUAY Gotze Ingenieria S.A.





Öhlins Racing AB Instrumentvägen 8-10 Box 722 SE-19427 Upplands-Väsby, Sweden
Phone: +46 (0)8 590 025 00 Mail: info@ohlins.se Web: www.ohlins.com

 **OHLINSRACING**

 **OHLINSRACING**

 **OHLINSRACING**

 **OHLINSRACING**